

www.mingardimotor.com

DRIVE EVO 2

... Mingardi range evolution



 **MINGARDI**[®]
THE REFERENCE FOR WINDOW AUTOMATION

> Drive Evo 2

Drive Evo 2 - CAMPO DI APPLICAZIONE APPLICATION FIELD



Finestre a sporgere
Top hinged windows



Finestre a bilico
Pivot windows



Lucernari
Skylights



Cupole
Domes



Sistemi frangisole
Sunshade systems

L'attuatore deve essere installato all'interno dell'edificio
The actuator has to be installed indoor



Drive Evo 2 offre la massima flessibilità grazie alle sue diverse configurazioni e voltaggi.

- > Idoneo per serramenti di grandi dimensioni in applicazione in tandem
- > Corse fino a 1000 mm
- > Voltaggio esteso 110 - 240V AC (50/60Hz)
- > RWA versione 24V DC
- > Corpo motoriduttore in alluminio
- > Grado di protezione: IP 55 parti elettriche
- > Chiusura soft stop per preservare il serramento
- > Cremagliera in acciaio
- > Staffa di fissaggio basculante scorrevole su tutto il corpo della cremagliera

Drive Evo 2 offers maximum flexibility thanks to its different configurations and voltages.

- > Suitable for wide window frames with tandem application
- > Strokes up to 1000 mm
- > Extended voltage range 110 - 240V AC (50/60 Hz)
- > RWA version 24V DC
- > Aluminium gearmotor body
- > Protection degree: IP 55 electrical parts
- > Soft stop closing to preserve the window frame
- > Steel rack
- > Fixing pivoting bracket sliding along the whole rack body



Testato in base alle specifiche della
Normativa Europea EN 12101 - 2: 2017

Tested in accordance with the requirements
of the European Standard EN 12101 - 2: 2017



Test report



> Drive Evo 2

Drive Evo 2 - CAMPO DI APPLICAZIONE APPLICATION FIELD



Finestre a sporgere
Top hinged windows



Finestre a bilico
Pivot windows



Lucernari
Skylights



Cupole
Domes



Sistemi frangisole
Sunshade systems

L'attuatore deve essere installato all'interno dell'edificio
The actuator has to be installed indoor



Drive Evo 2 - DESCRIZIONE DI CAPITOLATO DESCRIPTION OF SPECIFICATIONS

MINGARDI Attuatore elettrico lineare a cremagliera sezione 12 x 12 contenuta all'interno di un tubolare di alluminio. Tensione di funzionamento: 110 - 240 V AC (50/60 Hz) o 24V DC. Conforme alle Direttive Europee di riferimento. Versione 24VDC testata in base alle specifiche della Normativa Europea EN 12101 - 2: 2017. Predisposto di sistema di fine corsa elettronico in apertura e in chiusura con protezione da sovraccarico. Collegabile elettricamente in parallelo. Corpo motoriduttore in alluminio grigio RAL 9006, cremagliera in acciaio zincato. Completo di accessori di fissaggio.

MINGARDI linear electric actuator with movement by a 12x12 section rack contained inside the aluminium tubular. Operating voltages: 110 - 240 V AC (50/60 Hz) or 24V DC. In compliance with the relevant European Directives. 24V DC version tested in accordance with the requirements of the European Standard EN 12101 - 2: 2017. Outfitted with a system of electronic limit switch in opening and closing with overload protection. Possibility of electrical connection in parallel. Gearmotor body in aluminium grey RAL 9006, galvanized steel rack. Complete with fixing accessories.

Drive Evo 2 - 110 - 240V AC - CARATTERISTICHE TECNICHE TECHNICAL FEATURES

Voltaggio / Voltage	110 - 240 V AC (50/60 Hz)
Forza / Force	Spinta / Thrust: 1000N - Trazione / Tensile: 1000N
Fine corsa apertura e chiusura / Limit switch opening and closing	Elettronico / Electronic
Grado di protezione (per uso interno) / Protection degree (indoor use only)	IP 55 parti elettriche / electrical parts
Temperatura di funzionamento / Operating temperature	-10°C + 60°C

Drive Evo 2 - 24V DC RWA - CARATTERISTICHE TECNICHE TECHNICAL FEATURES

Voltaggio / Voltage	24V DC RWA
Forza / Force	Spinta / Thrust: 500N - Trazione / Tensile: 500N
Fine corsa apertura e chiusura / Limit switch opening and closing	Elettronico / Electronic
Grado di protezione (per uso interno) / Protection degree (indoor use only)	IP 55 parti elettriche / electrical parts
Temperatura di funzionamento / Operating temperature	-10°C + 60°C

Drive Evo 2 - CAVO DI ALIMENTAZIONE POWER SUPPLY CORD

110-240V AC: PVC nero / black L. 1500 mm

24V DC: SILICONE Nero / SILICON Black L. 1500 mm



DRIVE EVO 2

... Mingardi range evolution

Motoriduttore in alluminio Grigio RAL 9006
Aluminium gearmotor Grey RAL 9006



**Testato in base alle specifiche della
Normativa Europea EN 12101 - 2: 2017**
Tested in accordance with the requirements
of the European Standard EN 12101 - 2: 2017

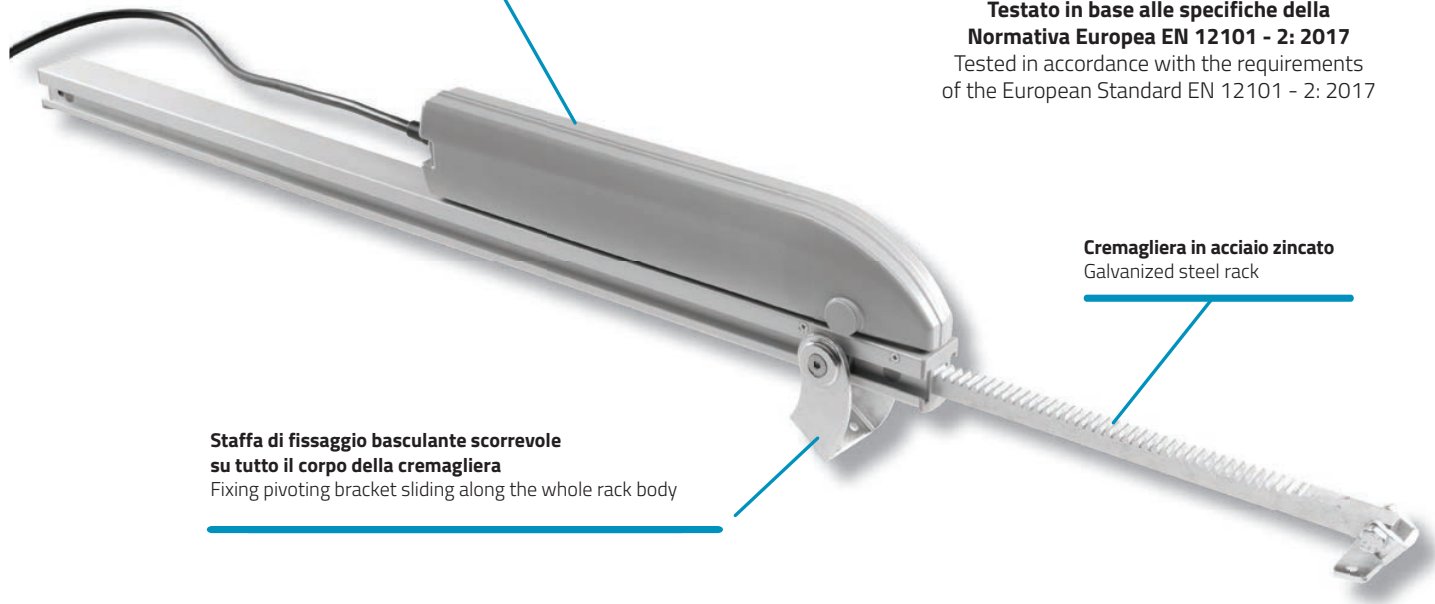

**Staffa di fissaggio basculante scorrevole
su tutto il corpo della cremagliera**
Fixing pivoting bracket sliding along the whole rack body

Cremagliera in acciaio zincato
Galvanized steel rack



Applicabile in tandem con la barra di collegamento (vedi schema pag. 69)
Tandem operation with connection rod (see page 69)

> Drive Evo 2

Drive Evo 2 - DIMENSIONALI MOTORIDUTTORE + CREMAGLIERA GEARMOTOR + RACK DIMENSIONS

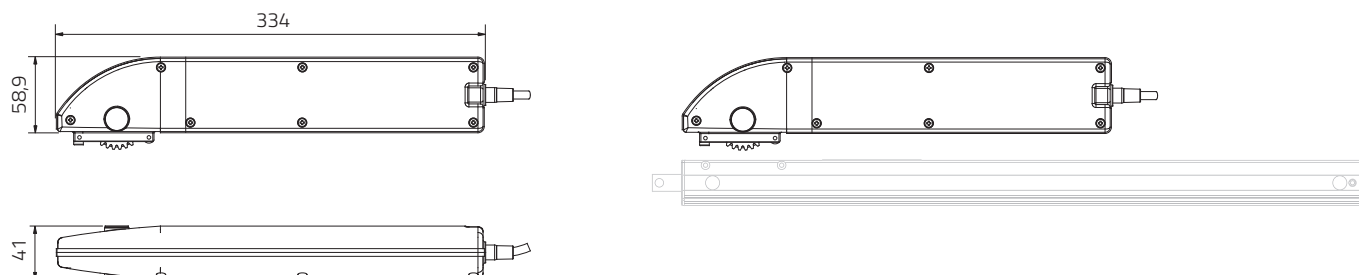

Drive Evo 2 - 110-240V AC (50/60 Hz) MOTORIDUTTORE GEARMOTOR

CODICE CODE	DESCRIZIONE DESCRIPTION	CORSA STROKE	SPINTA/TRAZIONE THRUST/TENSILE	POTENZA POWER	GRADO DI PROTEZIONE PROTECTION DEGREE	VELOCITA' MIN. SPEED MIN.	COLORE COLOR
2701034	Drive Evo 2	/	1000 N	35 W	IP 55 parti elettriche / electrical parts	~ 7 mm/s	Grigio / Grey

I valori prestazionali riportati nelle tabelle sono valori medi verificati in condizioni di utilizzo standard / The values indicated on the tables are average values were recorded in condition of normal use



Drive Evo 2 - 24V DC MOTORIDUTTORE GEARMOTOR

CODICE CODE	DESCRIZIONE DESCRIPTION	CORSA STROKE	SPINTA/TRAZIONE THRUST/TENSILE	POTENZA POWER	GRADO DI PROTEZIONE PROTECTION DEGREE	VELOCITA' MIN. SPEED MIN.	COLORE COLOR
2713839	Drive Evo 2 - RWA	/	500 N	34 W	IP 55 parti elettriche / electrical parts	~ 14 mm/s	Grigio / Grey

I valori prestazionali riportati nelle tabelle sono valori medi verificati in condizioni di utilizzo standard / The values indicated on the tables are average values were recorded in condition of normal use

Drive Evo 2 - CREMAGLIERA CON STAFFE RACK ASSEMBLY WITH BRACKETS

CODICE CODE	DESCRIZIONE DESCRIPTION
2700500	Cremagliera con staffe - 350 mm / Rack assembly with brackets - 350 mm
2700715	Cremagliera con staffe - 550 mm / Rack assembly with brackets - 550 mm
2700790	Cremagliera con staffe - 750 mm / Rack assembly with brackets - 750 mm
2700510	Cremagliera con staffe - 1000 mm / Rack assembly with brackets - 1000 mm

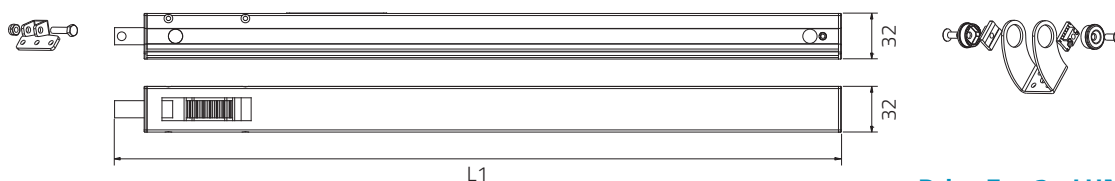

Drive Evo 2 - LUNGHEZZE LENGTHS

Corsa / Stroke	350 mm	L1 = 510 mm
Corsa / Stroke	550 mm	L1 = 710 mm
Corsa / Stroke	750 mm	L1 = 910 mm
Corsa / Stroke	1000 mm	L1 = 1160 mm

Drive Evo 2 - CONDOTTO GEAR DRIVEN

CODICE CODE	DESCRIZIONE DESCRIPTION
2700798	Condotto / Gear driven

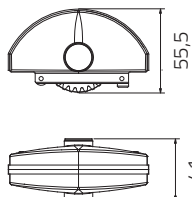

Drive Evo 2 - BARRA DI COLLEGAMENTO CONNECTION ROD

CODICE CODE	DESCRIZIONE DESCRIPTION
2700081	Barra di collegamento - Lunghezza 890 mm / Connection rod - Length 890 mm
2700085	Barra di collegamento - Lunghezza 1890 mm / Connection rod - Length 1890 mm

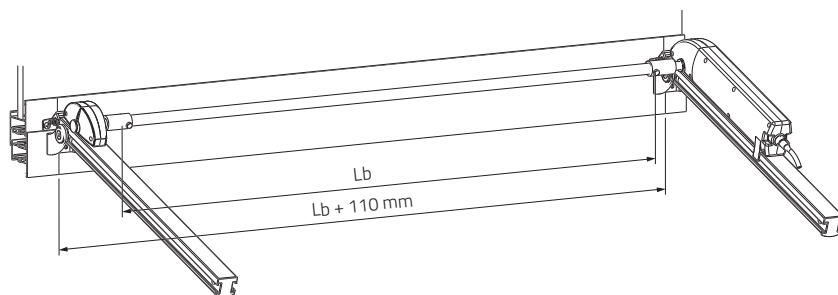

Drive Evo 2

Lb	Lb + 110 mm
890	1000
1890	2000 mm

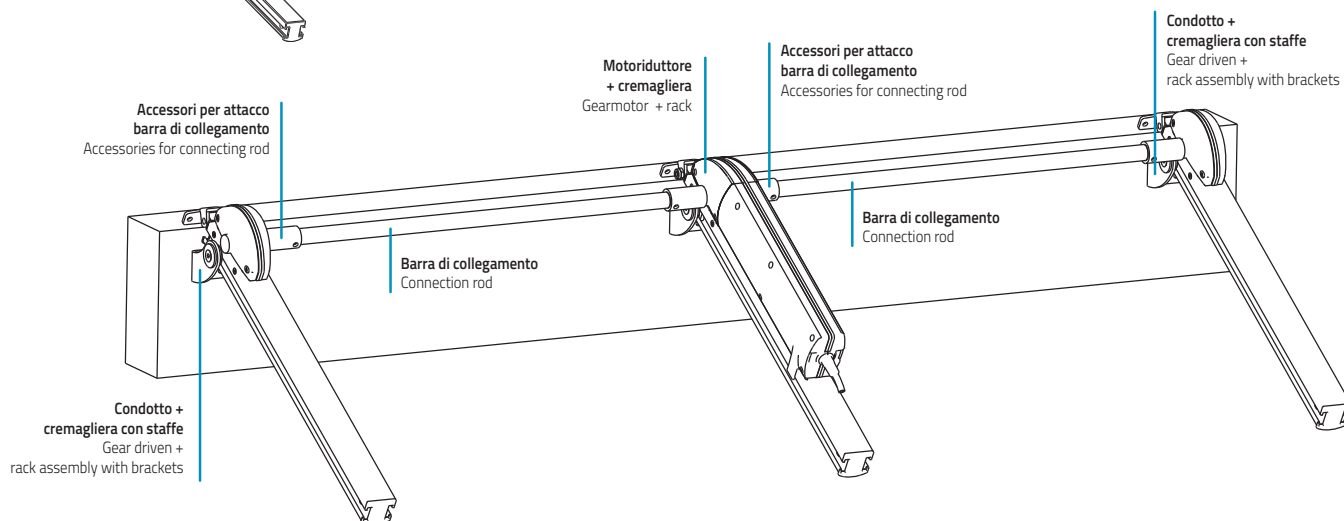

Drive Evo 2 - ACCESSORI ACCESSORIES

CODICE CODE	DESCRIZIONE DESCRIPTION
2700518	Gruppo accessori di fissaggio / Fixing brackets
2700086	Accessori per attacco barra di collegamento / Accessories for connecting rod

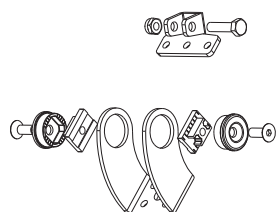

2700518

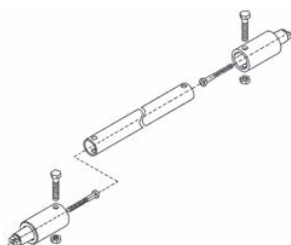

2700086